

YL CONNECTOR

<Meets glow wire testing standards>

4.5 mm pitch/Wire-to-Wire connectors/Crimp style and Mating style

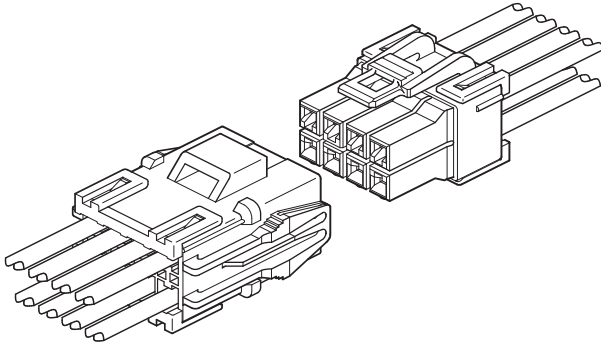

This is a 4.5 mm pitch, wire-to-wire connector that comes with glow-wire compliant housing material and allows the use of retainers.

- **Glow-wire compliant**

Meets the GWT 850°C standard, ensuring enhanced safety and reliability. Demonstrates improved protection and compliance in a wide range of household appliances.

- **Retainer**

Optional retainers enhance connection reliability by preventing incomplete insertion or accidental contact disengagement.

- **Inner type housing lance**

The contact is secured to a spring-loaded inner housing lance (a resin lance formed inside the housing). The inner housing lance provides a consistent, clear contact insertion feeling. The tactile "click" sensation contributes to improved manufacturing quality and productivity of wire harnesses.

- **Inner lock**

The lock connecting both receptacle and plug housings is an inner lock designed to resist irregular external forces, preventing issues such as lock disengagement.

- **Panel lock**

The receptacle housing is equipped with a panel lock that minimizes wire entanglement while enabling easy and secure mounting on a wide range of panel thicknesses. For design flexibility, a version without the panel lock is also available.

Specifications

- Current rating: 7 A AC/DC (2 circuits/AWG #18)

Note: The table below lists the current rating by number of circuits and wire size, with the assumption that each number of circuits is used.

No. of circuits	Wire size (AWG)					Unit: A
	#18	#20	#22	#24	#26	
2	7	5	4	3	2	
3	6	4	4	3	2	
4	6	4	4	3	2	
8	4	3	3	2	2	
10	4	3	3	2	2	
12	3	2	2	2	2	
20	3	2	2	2	1	

Note: Do not branch in parallel current which exceeds the rated current. If branched in parallel, current imbalance or other problems may occur. If it is absolutely necessary to branch such a large current in parallel, design the circuits without causing any imbalance and provide extra margin for each circuit.

- Voltage rating: 300 V AC/DC

- Temperature range: -25°C to +90°C

Note: Including temperature rise in applying electrical current

- Contact resistance: Initial value/ 7 mΩ max.

After test/ 10 mΩ max.

- Insulation resistance: 1,000 MΩ min.

- Withstanding voltage:

There shall be no breakdown or flashover while applying 1,500 VAC for one minute.

- Applicable wire range:

Conductor size/ AWG #26 to AWG #18

Insulation O.D./ ϕ 1.3 mm to ϕ 2.7 mm

Note: Refer to the "Contact" section on page 2 for information on when two wires are crimped together.

- Applicable panel thickness: 0.2 mm to 2.0 mm

Note: See "Panel layout" section on page 7 for further details.

- * Please refer to the "Handling Precautions for Terminals and Connectors" on our website (listed in the "Technical Documents" column on the Product Information page) before use.

- * RoHS2 compliance

- * Dimensional unit: mm

- * Contact JST for details.

Standards

For information on overseas standard registrations, please refer to the "List of Registered Overseas Standards" on our website (listed in the "Technical Documents" column on the Product Information page).

- * Specifications registered to overseas standards may differ from the general specifications listed above.

YL CONNECTOR <Meets glow wire testing standards>

Contact

Pin contact

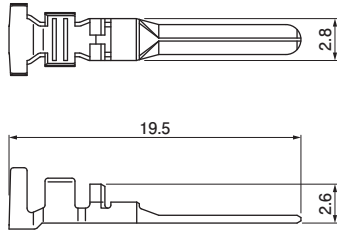

Socket contact

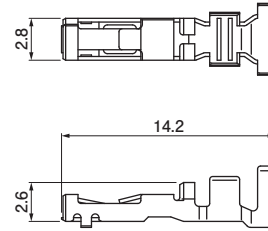

Pin contact

Model No.	Applicable wire range		Q'ty/ reel
	Conductor size AWG (mm ²)	Insulation O.D. (mm)	
SYM-01T-P0.5A	#26 to #20 (0.13 to 0.5)	1.3 to 2.5	5,000
SYM-41T-P0.5A	#20 to #18 (0.5 to 0.75)	2.0 to 2.7	4,000
	#22+#22 to #20+#20 (0.3+0.3 to 0.5+0.5)	1.5+1.5 to 2.0+2.0	

Material and Surface finish, etc.

Copper alloy, tin-plated

Note: Contact JST for special specifications.

Crimping machine

Contact	Crimping machine	Applicator	Crimp applicator with dies
SYM-01T-P0.5A	AP-K2N	MKS-L	APLMK SYF/M01-05
SYM-41T-P0.5A			APLMK SYF/M41-05

Note: Contact JST for fully automatic crimping applicator.

Socket contact

Model No.	Applicable wire range		Q'ty/ reel
	Conductor size AWG (mm ²)	Insulation O.D. (mm)	
SYF-01T-P0.5A	#26 to #20 (0.13 to 0.5)	1.3 to 2.5	4,000
SYF-41T-P0.5A	#20 to #18 (0.5 to 0.75)	2.0 to 2.7	
	#22+#22 to #20+#20 (0.3+0.3 to 0.5+0.5)	1.5+1.5 to 2.0+2.0	

Material and Surface finish, etc.

Copper alloy, tin-plated

Note: Contact JST for special specifications.





Crimping machine

Contact	Crimping machine	Applicator	Crimp applicator with dies
SYF-01T-P0.5A	AP-K2N	MKS-L	APLMK SYF/M01-05
SYF-41T-P0.5A			APLMK SYF/M41-05

Note: Contact JST for fully automatic crimping applicator.

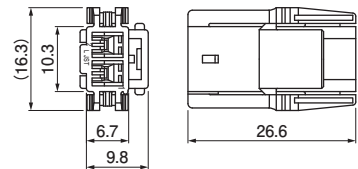
YL CONNECTOR <Meets glow wire testing standards>

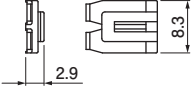
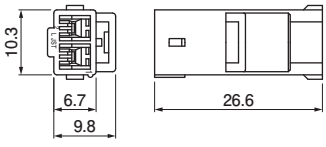
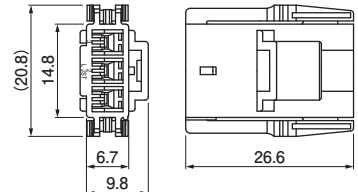
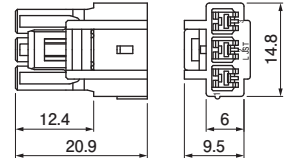
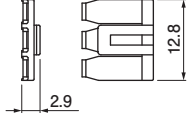
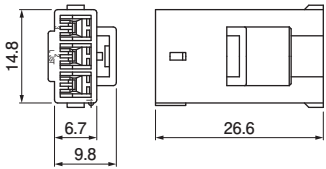
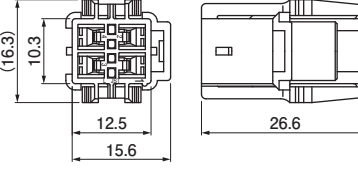
Housing

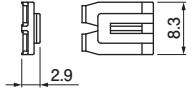
No. of circuits	Receptacle housing (For pin contact)	Q'ty /bag	Plug housing (For socket contact)	Q'ty /bag	Retainer	Q'ty /bag
2	YLR-02V-WGL1-Y 	500	YLP-02V-WGL1-Y 	500	YLS-02V *Used for both the 2 and 4 position housing. 	1,000
	YLR-02VF-WGL1-Y 					
3	YLR-03V-WGL1-Y 	500	YLP-03V-WGL1-Y 	500	YLS-03V 	1,000
	YLR-03VF-WGL1-Y 					
4	YLR-04V-WGL1-Y 	500	YLP-04V-WGL1-Y 	500	YLS-02V *Used for both the 2 and 4 position housing. 	1,000

Material and Surface finish, etc.

Receptacle housing: Thermoplastic resin, yellow
 Plug housing: Thermoplastic resin, yellow
 Retainer: PA (GF), ivory

Note: 1. Contact JST for special specifications.
 2. For flame retardant grade of resin material used, please refer to the "List of Registered Overseas Standards" on our website (listed in the "Technical Documents" column on the Product Information page).

YL CONNECTOR <Meets glow wire testing standards>

Housing

No. of circuits	Receptacle housing (For pin contact)	Q'ty /bag	Plug housing (For socket contact)	Q'ty /bag	Retainer	Q'ty /bag
8	YLR-08V-WGL1-Y 	250	YLP-08V-WGL1-Y 	500	YLS-08V 	1,000
10	YLR-10VF-WGL1-Y 	200	YLP-10V-WGL1-Y 	200	YLS-20V *Used for both the 10 and 20 position housing. 	1,000
12	YLR-12VA-WGL1-Y 	200	YLP-12VA-WGL1-Y 	200	YLS-12V 	1,000

Material and Surface finish, etc.

Receptacle housing: Thermoplastic resin, yellow
 Plug housing: Thermoplastic resin, yellow
 Retainer: PA (GF), ivory

- Note: 1. Contact JST for special specifications.
 2. For flame retardant grade of resin material used, please refer to the "List of Registered Overseas Standards" on our website (listed in the "Technical Documents" column on the Product Information page).

YL CONNECTOR <Meets glow wire testing standards>

Housing

No. of circuits	Receptacle housing (For pin contact)	Q'ty /bag	Plug housing (For socket contact)	Q'ty /bag	Retainer	Q'ty /bag
20	<p>YLR-20V-WGL1-Y</p>	100	<p>YLP-20V-WGL1-Y</p>	200	<p>YLS-20V *Used for both the 10 and 20 position housing.</p>	1,000

Material and Surface finish, etc.

Receptacle housing: Thermoplastic resin, yellow

Plug housing: Thermoplastic resin, yellow

Retainer: PA (GF), ivory

- Note: 1. Contact JST for special specifications.
 2. For flame retardant grade of resin material used, please refer to the "List of Registered Overseas Standards" on our website (listed in the "Technical Documents" column on the Product Information page).

YL CONNECTOR <Meets glow wire testing standards>

Contact position location numbers

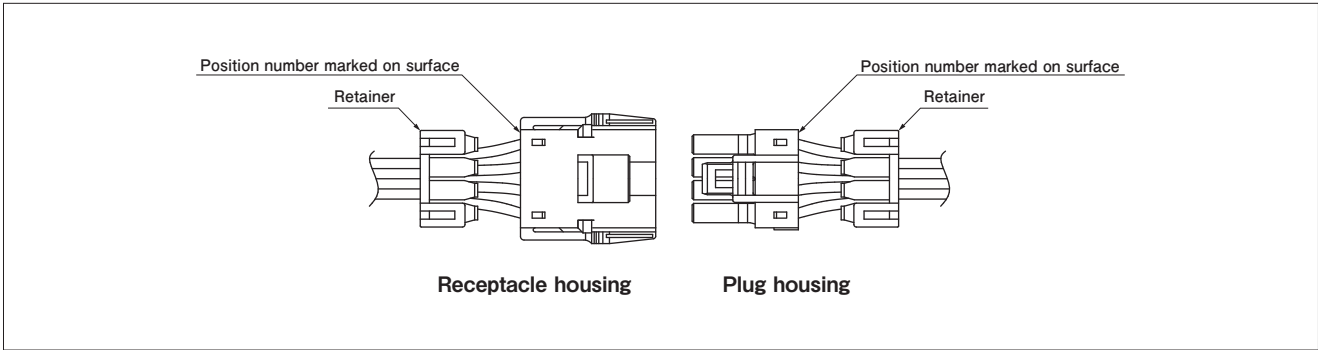

Receptacle housing

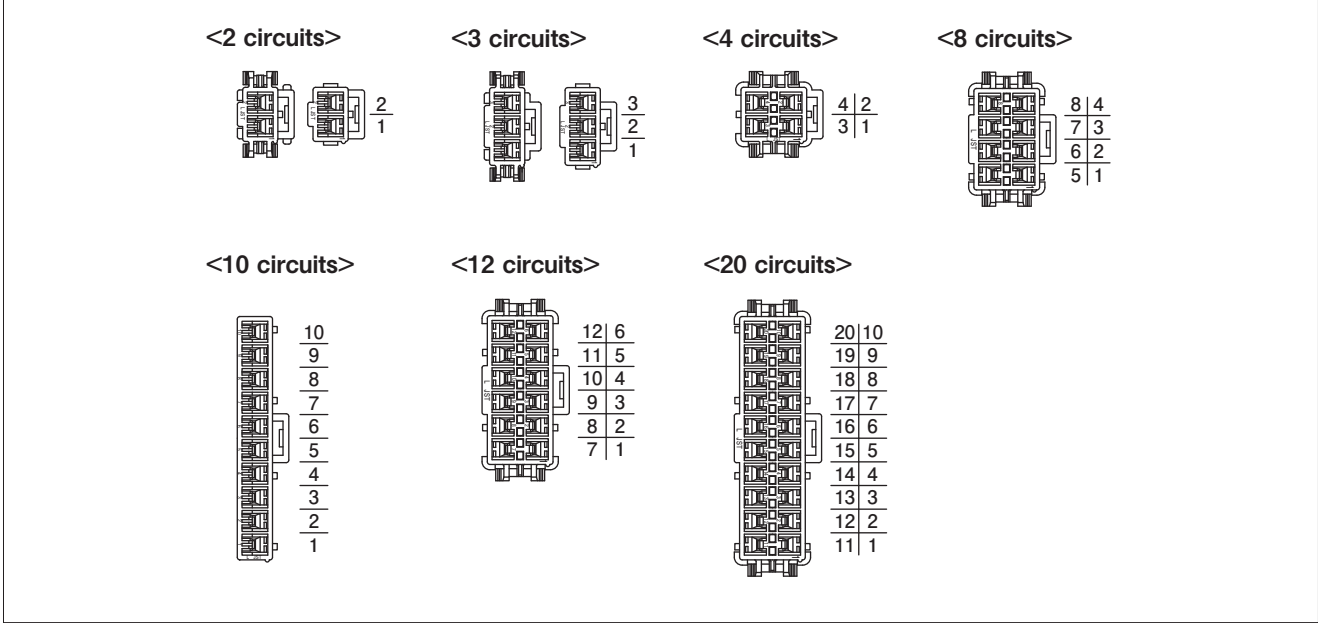

Plug housing

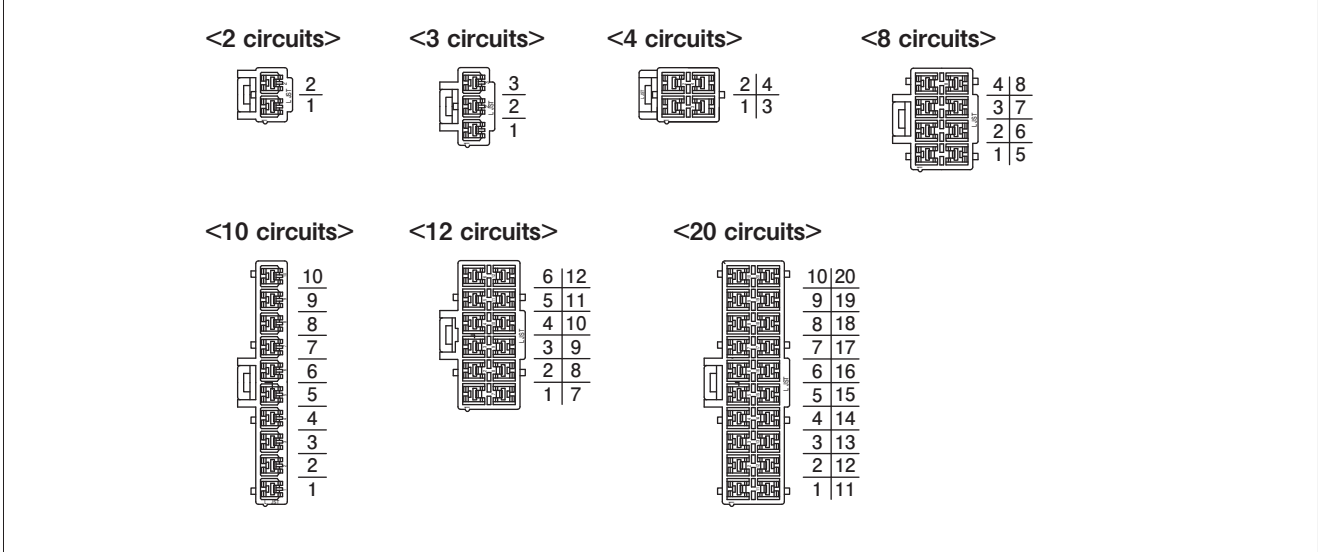

YL CONNECTOR <Meets glow wire testing standards>

Assembly layout and Panel layout

Assembly layout

• Single-row type

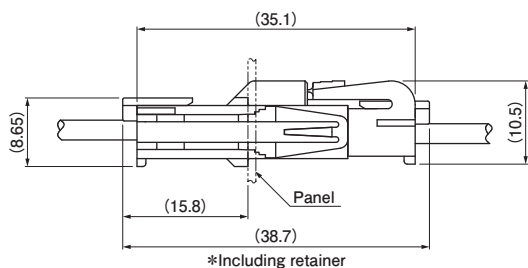

• Dual-row type

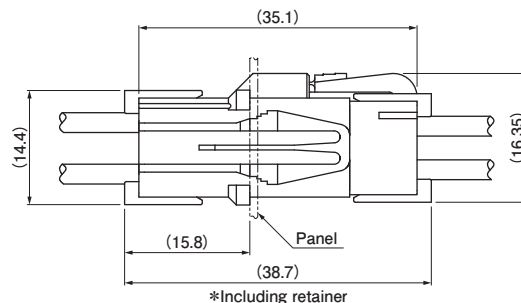

Panel layout

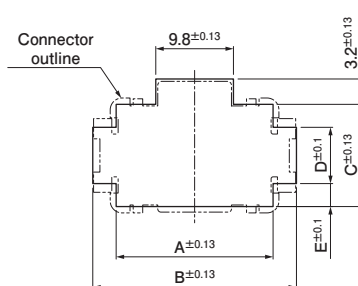
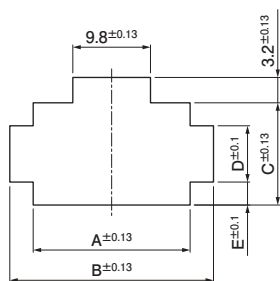

No. of circuits	Receptacle housing	Panel thickness (mm): 0.6~2.0			Panel thickness (mm)					
		A	B	C	0.6 to 0.8		0.9 to 1.3		1.4 to 2.0	
					D	E	D	E	D	E
2	YLR-02V-WGL1-Y	10.7	16.8	7.1	4.4	1.35	5.0	1.05	5.6	0.75
3	YLR-03V-WGL1-Y	15.3	21.3	7.1	4.4	1.35	5.0	1.05	5.6	0.75
4	YLR-04V-WGL1-Y	10.7	16.8	12.9	7.1	2.9	7.7	2.6	8.3	2.3
12	YLR-12VA-WGL1-Y	28.9	34.8	12.9	7.1	2.9	7.7	2.6	8.3	2.3

No. of circuits	Receptacle housing	Panel thickness (mm): 0.2 to 2.0			Panel thickness (mm)							
		A	B	C	0.2 to 0.4		0.5 to 0.8		0.9 to 1.3		1.4 to 2.0	
					D	E	D	E	D	E	D	E
8	YLR-08V-WGL1-Y	19.8	25.8	12.9	6.5	3.2	7.1	2.9	7.7	2.6	8.3	2.3
20	YLR-20V-WGL1-Y	46.9	52.9	12.9	6.5	3.2	7.1	2.9	7.7	2.6	8.3	2.3

- Note: 1. Drill holes correspond to panel layout dimensions to prevent the formation of burrs, etc.
 2. When drilling multiple panel holes adjacent to each other, pay sufficient attention to the strength of the panel.
 3. Please ensure that the panel cutout is oriented to match the connector mounting direction.